

OI-006B-2008

请务必在使用前仔细阅读使用说明书。

Please carefully read Instruction Manual before use.



TAILONG



使用说明书

Operating instruction

减速传动 当选泰隆

地址:江苏省泰兴市大庆东路88号

NO. 88, Daqing Rd. (E) Taixing City, Jiangsu Province

电话 (Tel): 0086-523-87635698 87668018 87668028

传真 (Fax): 0086-523-87665426 87665000

邮编 (P. C.): 225400

Http://www.tailong.com

E-mail: tloffice@126.com



齿
轮
减
速
电
机

江苏泰隆减速机股份有限公司

Jiangsu Tailong Decelerator Co., Ltd.

尊敬的泰隆减速机用户：

您好！

非常感谢您购买泰隆牌减速机，使我们有机会为您提供服务。我们会尽最大努力，使你的设备运转自如，让你享受到泰隆减速机卓越的性能和优良的品质带给您的最佳传动感受。

泰隆售后服务中心竭诚为您提供专业化、全方位的服务。

我们希望这本“使用说明书”能成为您在使用泰隆减速机过程中的一个好帮手，无论你在何时、何地，都能按操作方法得心应手，得到我们的服务，体会到泰隆人“专业专注，全心服务”带给你的愉快感受。

我们深知，您-泰隆减速机用户的满意是我们客户服务的目标。我们会不断努力，力使每一次使用泰隆减速机都是一次愉快的值得记忆的经历。

再次感谢您使用泰隆减速机，并希望有更多的机会为您提供服务！

江苏泰隆减速机股份有限公司

减速传动 当选泰隆





重要的安全说明

概述

注意: • 减速器的承载能力及热功率的选择参照本公司当年最新样本。

包装、吊运、接收、储存

危险: • 减速器外表面使用的油漆应为阻燃油漆。

警告: • 在吊运过程中不得与酸碱物质接触。

注意: • 在有专用运输工具运输时，一般采用裸装或局部包装。此说明书中所涉及包装图样仅作示意，若采用其它包装方法，包装实物以合同标的为准。

• 货物如有异样，请与我公司发运部门联系，服务电话：0523-87666499。

• 国产油封，在正常环境下和工况下，保证有效寿命为 6 个月。若使用进口油封，务必在合同中注明。

安装

危险: **安全提升** 执行所有提升和搬运操作时都严禁撞击轴端，以免损坏内部轴承或引起轴向窜动。使用专用吊具或特别设计的吊环螺栓，以确保提升装置具有足够的力量。绝对禁止对吊具进行焊接。

安全开启 所有安装或维护工作都必须在减速器停止转动时进行，因此防止意外开启驱动电源是一条重要的安全原则。

安全连接 与轴、带有传动带的接头或皮带轮等旋转件连接时，必须提供适当的事故预防措施。

警告: • 所有安装操作都必须遵守确保最高安全的以下要求：

- 操作人员和第三方的安全。
- 操作安全。

润滑

注意: • 泰隆减速器不附带润滑油，因此用户必须在启动机器之前，正确加注润滑油。

• 泰隆技术研发中心在为用户设计减速机时就根据使用状况选择了合适的润滑方式。

维护与保养

危险: • 请勿在减速机运行过程中卸下视镜盖，以免高温齿轮油飞溅，造成人身伤害。

警告: • 如果用户对减速器的安装和使用并不熟悉，但由于维修的需要必须拆卸主机设备或减速器时，请通知我公司寻求技术支持或经我公司同意。如果因用户私自装拆造成减速器或其他设备因非正常使用造成损坏，其责任应由用户承担。

易损件

注意: • 具体型号、名称由用户自行测量或咨询泰隆技术研发中心。

目录

概 述	1
包装、吊运、接收、储存	2
安 装	4
运 转	6
润 滑	8
维护与保养	14
常见的故障及排除方法	15
易损件	16
售后服务联系方式	16

1 概述

本说明书针对的减速机型号包括但不限于：P、R、K、S、CJY、TY。

对类似齿轮减速电机的减速机使用可参照本说明书。

减速机在出厂前均已进行过空运转试验，出厂时减速机内润滑油已全部排出，并按订货合同的规定进行包装。除合同中另有说明外（如用户要求协助安装），出厂后对减速机进行的所有活动均已不属于我公司所能控制的范围。故本说明书特别提醒并明确以下活动事项：

- 存放和防腐蚀
- 运输
- 超期存放
- 安装
- 启动前的检查
- 减速机的空负荷运转
- 操作和维护。

1.1 执行标准

本说明书适用的减速机符合以下标准的要求：

Q/321283JBJ08 TL 模块化组合齿轮减速机

1.2 适用范围

该类减速机适用于冶金、矿山、化工、建材、起重、运输、纺织、造纸、仪器、塑料、橡胶、工程机械、能源等工业部门。

1.3 工作条件

- 输入轴最高转速不大于 1500r/min；
- 齿轮圆周速度不大于 20m/s；
- 工作环境温度为-10℃~+40℃，当环境温度低于 0℃时，启动前润滑油应加热。
- 特殊工况下的减速机应用，需见本说明书附件。

●重要说明：减速机的承载能力的选择参照本公司当年最新样本。具体

详情，请咨询泰隆技术研发中心。

2 包装、吊运、接收、储存

2.1 包装

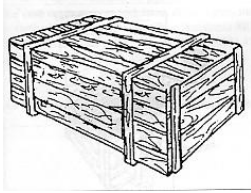

●**重要说明：**在有专用运输工具运输时，一般采用裸装或局部包装。此说明书中所涉及包装图样仅作示意，若采用其它包装方法，包装实物以合同标的为准。

- a. 包装箱内的减速机轴伸与键均匀涂上防锈油脂，用塑料薄膜裹严，捆紧，备用的齿轮、轴、轴承涂润滑脂后，固定于箱内。
- b. 减速机采用塑料袋封装，必要时采用真空包装。减速机应平衡放置，无倾斜。包装箱内应放置防水石油沥青油毡，保证箱内干燥、清洁。
- c. 包装方式主要有箱装（木箱、瓦楞纸箱、胶合板箱、金属箱等）、裸装、局部包装。

2.2 吊运

a. 起吊时须按包装箱图示起吊位置正确起吊，起吊时应有防护措施，防止其表面被钢丝绳等物擦伤或碰伤。减速机在运输存放时应放置在木块或平滑干燥的基础之上，请勿直接放在水泥地面上。运输时进行可靠的固定，防止撞击，防止轴转动。减速机可利用箱体上的吊耳起吊（当下箱体有吊耳时，必须使用下箱体的吊耳起吊）。

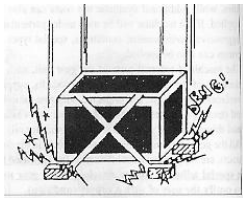

注意：在吊运过程中不得与酸碱物质接触。

- b. 铲车在搬运时需使重量在台叉板上平衡，防止侧翻。



如果需要，把木制楔块放在包装物下面，容易提起。

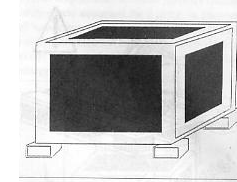

- c. 当吊钩吊包装箱时，绳索上的载荷要平稳。并确保吊绳及提升的工具质量是被鉴定合格的。

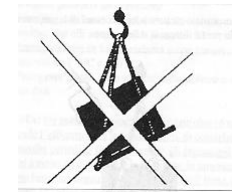
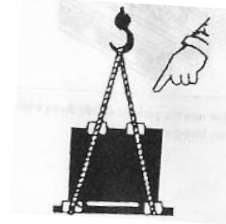

2.3 接收



- a. 随机文件一般包括使用说明书、合格证明书（合格证）、装箱单（包括总装箱单和分装箱单）等。产品分多箱包装时，使用说明书、合格证明书、总装箱单一般放在主机箱内，分类装箱单应放在相应的包装箱内。

- b. 开箱时应核对产品的型号、规格是否正确；零部件及附件是否齐全；技术文件是否齐全；检查运输及存放过程中有无损伤、锈蚀。（如发现有损伤和锈蚀，应查清原因，并予以修复，修复的质量应经制造厂和使用单位共

同认可后才可使用。) 除非在合同中指明, 否则减速机外表喷 901 酞青绿锤纹漆, 这种保护符合正常工业环境 (也是外部的) 要求, 如果预料中要在某种侵蚀性条件下使用, 则须使用专用油漆。

● **重要说明:** 货物如有异样, 请与我公司发运部门联系, 服务电话: 0523-87666499。

2.4 储存

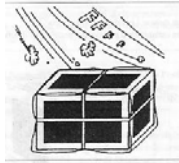

减速机严禁在室外存放。其防腐期为自发货之日起在室内存放六个月。如果预计存放六个月以上, 或在潮湿腐蚀性环境工作的减速机, 应在订货合同中明确说明, 以便在出厂试验后作特殊的防腐处理。

存放期超过允许的防腐期时应重新进行防腐处理, 具体办法可向我公司咨询。

减速机外表面重新涂漆时应防护好油封, 以免油漆中的溶剂和橡胶接触后引起橡胶老化, 导致油封漏油。

- 禁止互相堆放在一起。
- 禁止站在或放东西在包装箱的顶上。
- 在包装箱内禁止保存其它任何物品。
- 保持包装物远离任何一个行走通道。

● **重要说明:** 国产油封, 在正常环境和工况下, 保证有效寿命为 6 个月。若使用进口油封, 务必在合同中注明。

3 安装

减速机必须由经过培训的合格技术人员精心安装, 严格按装配图中列出的所有技术要求进行准备工作。

警告: 所有安装操作都必须遵守确保最高安全的以下要求:

- 操作人员和第三方的安全。

- 操作安全。

3.1 减速机为整体供货, 整体安装, 在现场不必进行重新解件和装配。严禁随意篡改原装齿轮传动结构和任何附件。减速机的工作环境及安装的现场应满足的条件

- 在高温时, 若减速机正常工作的冷却条件不满足 (超过许可的热功率时), 允许采用一定的热交换措施;
- 在低温时, 要避免在低于允许温度下启动, 润滑油要预热;
- 不得使水和污物进入箱体内部。

3.2 安全提升 执行所有提升和搬运操作时都严禁撞击轴端, 以免损坏内部轴承或引起轴向窜动。使用专用吊具或特别设计的吊环螺栓, 以确保提升装置具有足够的力量。绝对禁止对吊具进行焊接。

3.3 安全开启 所有安装或维护工作都必须在减速机停止转动时进行, 因此防止意外开启驱动电源是一条重要的安全原则。

3.4 安全连接 与轴、带有传动带的接头或皮带轮等旋转件连接时, 必须提供适当的事故预防措施。

3.5 基础 减速机的基础可以是混凝土基础, 钢制底座或铸铁底座。基础或底座必须牢固、可靠, 有足够的刚度。基础不可靠, 运转时会增大振动及噪声, 影响齿轮和轴承的使用寿命。底座表面应有一定的平面度和粗糙度要求。底座设计时应考虑排放油、拆装回油管及维修时方便, 靠重力回油应有足够的落差。对于装备有凸缘的齿轮装置, 建议遵循以下要求:

- 连接固定设备必须坚硬, 支持平面未上漆, 经机械加工非常平坦。
- 接触面必须适时涂上适量润滑油; 减速机必须小心地与从动轴对齐, 特别是对于具有内花键从动轴的齿轮装置更是如此, 要牢记不得施加外部载荷。

3.6 轴连接 输入轴和输出轴与动力及配套机械连接时, 如用联轴器, 则要求轴与轴严格对中, 不得有不同心现象, 否则将会产生附加弯矩, 严重者导致断轴, 使用三角皮带和链条不宜过紧或过松。如果误差值过大, 请给原动机或减速机加垫片, 使其进入允许范围。垫块在高度方向不得超过 3 块。垫块的配置要避免引起箱体变形, 应在地脚螺栓两侧对称排列。拧紧地脚螺

栓后，用百分表在螺栓附近的箱体上检查，当螺栓被松开时箱体移动，说明基础不平或垫块未垫好，应重新对中。冲击载荷的情况应考虑地脚螺栓的防松和防止工作一段时间后对中位置的移动，底座上应设顶紧螺栓。当工作时（热态）和停机时（冷态），减速机和相连接机械的轴心位置有较大变化时，安装时应考虑一定的补偿量以同时满足两种状态的要求，特别是应使热态时有较小的对中误差。

3.7 联轴器与锁紧盘 往减速机的轴伸上装配联轴器等联接件时，不允许用锤子敲打，应利用减速机出轴端螺纹，将联轴器等联接件压入进去。对于配有锁紧盘的 P、K、S 减速机，锁紧盘请按以下方法安装：

- a. 拆掉运输中起保护作用的外圈中间隔板。
- b. 取任意三个锁紧螺钉形成一个等腰三角形，并将它们轻轻拧紧，直至内圈仍可转动为止，用力过猛拧紧会导致内圈产生变形。
- c. 让锁紧盘在轴套上滑动，轴套外圈可加脂润滑。（注意：轴装进轴套之前切记不要拧紧锁紧螺钉）。
- d. 擦净轴及轴套内孔的油脂。
- e. 将轴插入轴套并让轴套在轴上滑动。
- f. 锁紧盘要按以下规定的力矩用力矩扳手扭紧。

锁紧盘拧紧螺栓规格	M12	M16	M20	M24	M27
拧紧力矩 Nm	75	170	340	590	870

4 运转

4.1 启动前的检查

启动前应按次序进行下列检查，确认无误后方可转入试运转：

- ①安装位置的准确性；
- ②各紧固件紧固的可靠性；
- ③飞溅润滑的油面调试高度是否符合要求，油的牌号及粘度是否符合工作要求；
- ④当带有循环油润滑系统，冷却系统及监控系统时，需检查：

- 管路联接的正确性；

- 管路联接的各紧固件紧固的可靠性；
- 油泵转向的正确性；
- 压力表、监测仪表、控制装置、开关是否牢固可靠；
- ⑤原动机转向是否正确；
- ⑥联轴器防护罩、接地线及其他防护装置是否装好。

4.2 试运转

减速机安装好后应按工作转速先进行空载试运转，时间 2 小时左右。

- 对油浴润滑的减速机，当环境温度低于所用润滑油允许的最低温度时，启动前应将润滑油预热，以降低启动转矩（否则有可能损坏齿轮或烧坏电动机）和使各润滑油点都能飞溅到油。

• 油浴润滑时的油位由测油尺或油标来监测，出厂已作过标定。但因不同用户使用的工作转速不同，油位高低应有所不同。油位过高会使减速机内润滑油搅动太厉害，增加功率消耗，引起温升太高；油位过低会使轴承和齿轮的润滑油不良而过早损坏，试车时，请打开箱盖上的观察孔板，观察油的飞溅情况，以油能飞溅到箱体内的集油器上，轴承上方的油池能溅到足够的润滑油为最佳油位。此油位若和原刻度有较大差别，请重新标定刻度尺。

- 对带循环油润滑系统的减速机，测油尺或油标仅起参考作用。启动前应将润滑油加热到 0℃ 以上。先启动润滑油系统，检查给齿轮、轴承的供油是否正常，供油压力是否在规定的范围内，回油是否正常，使润滑油先循环 30 分钟左右。

正常供油压力：0.12-0.25Mpa。

4.3 负载运转

与工作机联动空运转运行 2 小时后可按 25%、50%、75% 的负载逐级加载试车，直到满负荷运行。

负载运行一段时间后，应检查一次齿面接触及紧固件是否松动等情况。一切正常后即可转入正常使用。

5 润滑

●注意：泰隆减速机不附带润滑油，因此用户必须在启动机器之前，正确加注润滑油。

5.1 本减速机中润滑脂常用 3#工业脂。

5.2 本减速机一般选用 GB5903 中的中负荷工业齿轮油 L-CKC220、L-CKC320。下表给出减速机在不同的环境温度时，推荐采用的润滑油（矿物油）粘度牌号。

低速轴转速 r/min	润滑油标准	环境温度℃		
		-10~+15	0~+30	+10~+50
≤100	ISO	VG150	VG320	VG460
	GB	150	320	460
	AGMA	4EP	6EP	7EP
>100	ISO	VG100	VG220	VG320
	GB	100	220	320
	AGMA	3EP	5EP	6EP

a、**油位** 减速机一般采用油池润滑，使用前一定要加好油至规定位置（按图示意位置），并定期更换。

P系列斜齿轮减速机油位、螺塞、通气帽位置图

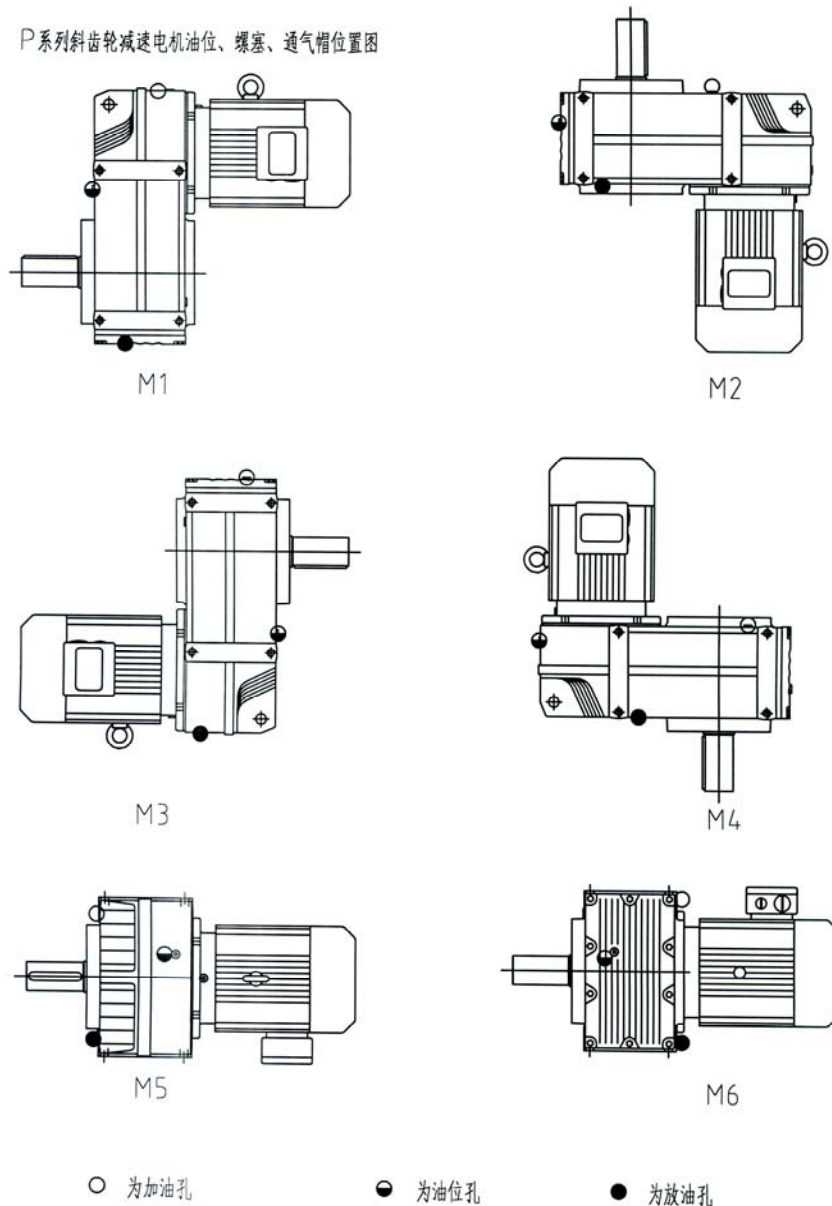

R系列斜齿轮减速电机油位、螺塞、通气帽位置图

9

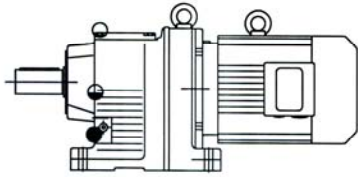

M1

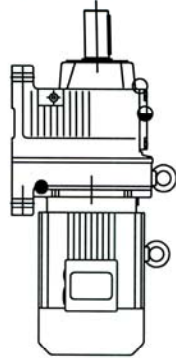

M2



M3

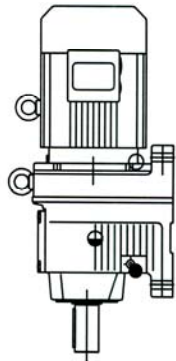

M4

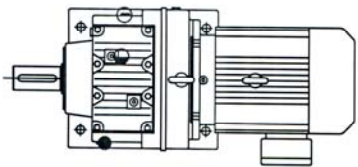

M5

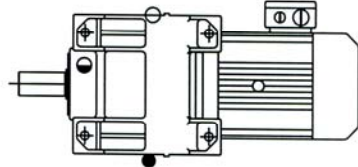

M6

○ 为加油孔

◐ 为油位孔

● 为放油孔

10 K系列斜齿轮-伞齿轮减速电机油位、螺塞、通气帽位置图

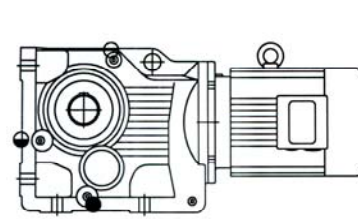

M1

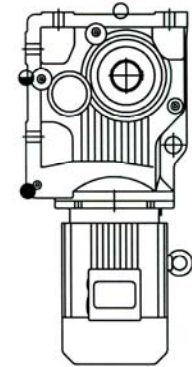

M2

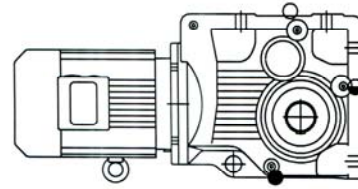

M3

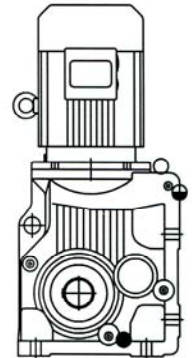

M4

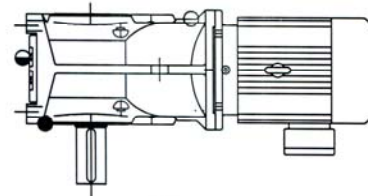

M5

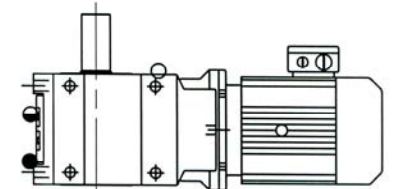

M6

○ 为加油孔

◐ 为油位孔

● 为放油孔

S系列斜齿轮-蜗轮蜗杆减速机油位、螺塞、通气帽位置图

11

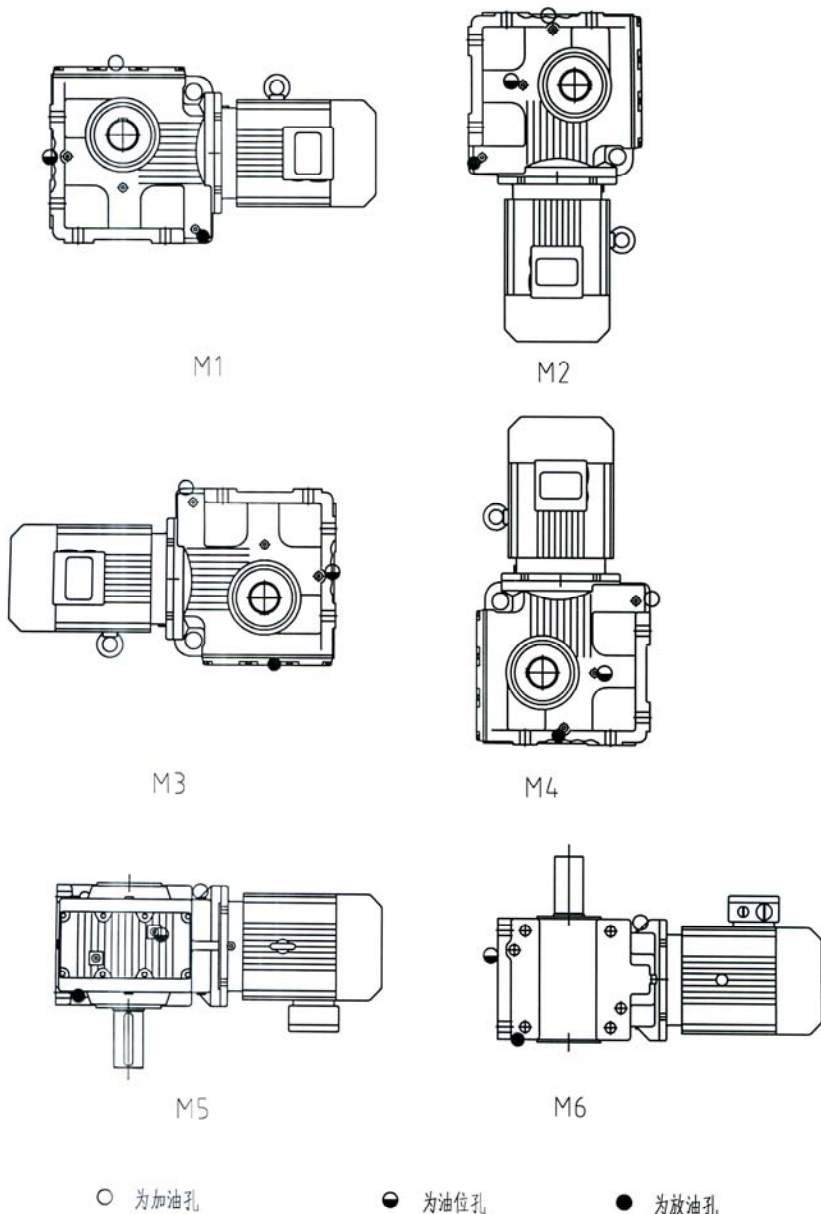

b. **换油周期** 新减速机第一次使用时，经运转 7~14 天（150~300 小时）的磨合期后，必须更换新油。使用至 3 个月时必须第二次更换新油。在以后的使用过程中，应定期检查油质，必须随时更换含有杂质、污染、或已分解、老化的变质油品。一般情况下，长期连续工作的减速机可 6~8 个月应更换一次油，而每天工作不超过 8 小时的减速机可 10~12 个月更换一次。

c. **油品** 更换的新油必须与原来使用的油品牌号相同，不应把不同牌号和不同类型的油品混用。

注入新油之前，把和运转时所用的相同型号的油加热，然后用它清洗齿轮。

d. **油温** 减速机允许的工作温度主要取决于润滑油的品种，油温控制得过高会使润滑油加速老化，缩短换油期而不经济。

5.3 **润滑方式** 减速机一般采用油池润滑，自然冷却。

当减速机工作平衡温度超过 90℃ 或承载功率超过热功率 P_{G1} 时，可采用循环油润滑，或采用加冷却管的油路润滑。

当减速机连续停机超过 24h 后再启动时，应使齿轮和轴承充分润滑正常后方可带负荷运转。

5.4 **轴承润滑** 减速机中滚动轴承的润滑，常采用的润滑剂有润滑油和润滑脂两种。

选择润滑油时，应考虑到轴承的负荷、转速、温度和工作环境等因素。轴承的负荷大，温度愈高，采用润滑油的黏度应愈高。轴承的负荷小、温度低和转速高时，可用黏度小的润滑油。

轴承中润滑油过多或过少，都将引起轴承过热现象。当轴承转速 $n=1500\text{r/min}$ 时，油面不宜超过轴承下部滚动体的中心。当 $n>1500\text{r/min}$ 时，油面应更低些。

在轴承转动座圈圆周速度不大于 4-5m/h，可采用润滑脂润滑。采用润滑脂润滑时，轴承中润滑脂装入量可占轴承室空间的 1/3-1/2。

减速机中滚动轴承的润滑法，可直接利用减速机油池中的润滑油，这时必须将减速机油池内的润滑油引入轴承。

● **注意：**泰隆技术研发中心在为用户设计减速机时已根据使用状况选择

了合适的润滑方式。

6 维护与保养

6.1 备件制造 减速机应定期检查与检修。发现擦伤、胶合及显著磨损，必须采取有效措施。备件必须按标准制造，更新的备件必须经过跑合和负荷试车后，才能正式使用。

6.2 传动检查 减速机在使用过程中，应密切注意各传动部分的转动灵活性，对使用过程中发现的异常声音及高温现象应加以分析，及时处理隐患，当发现轴承有异常声音时应及时检查，必要时更换轴承，如果轴承损坏后不及时更换会严重损坏齿轮。如不能自行解决，应立即停机检查，并与本公司售后服务部门联系。

6.3 油量油压 经常检查螺栓紧固程度和油量。减速机的油位低于油标尺的下刻度线时应及时补充油。循环油润滑应注意油压的变化，当油压有明显降低时，应检查清洗滤油网。

6.4 散热检查 为使减速机易于散热，其外表面应保持清洁，通气孔不得堵塞。如箱体温升过高，应检查是否油位过高，是否周围散热条件不好，油质老化，或冷却水量不够，冷却盘管内结垢冷却效果不好等原因。

6.5 漏油检查 如发现高速轴漏油，应检查是否油位过高。如轴封因老化或磨损而漏油时，可通过端盖上的黄油咀注入适量黄油，如漏油严重，用户应及时自行更换油封。

●重要说明：减速机运转 8 小时后，密封件附近仅小面积浸润油为不渗油，浸润面积扩展至底座为渗油，在地基上有积油为漏油。

6.6 安全防护 减速机外露的回转部分应设置防护罩，与电动机或其他电器设备联接时应接地。

●重要说明：请勿在减速机运行过程中卸下视镜盖，以免高温齿轮油飞溅造成人身伤害。

6.7 换油 在正常运转过程中，由于表面的持续运转，金属微料不可避免地进入机油。这些污物会缩短轴承的寿命，导致齿轮装置提前报废，所以要借助于频繁更换机油来维护。

6.8 制度管理 用户应有合理使用维护规章制度，对减速机的运行情况和检验中发现的问题应作认真记录。

●重要说明：如果用户对减速机的安装和使用并不熟悉，但由于维修的需要必须拆卸主机设备或减速机时，请通知我公司寻求技术支持或经我公司同意。如果因用户私自装拆造成减速机或其他设备因非正常使用造成损坏，其责任应由用户承担。

7 常见的故障及排除方法

序号	现象	原因	排除方法
1	油管无油	机内油面太低	向机内增加润滑油
		油路堵塞	拆下油泵清洗
		油泵损坏	更换新油泵
2	过热	原动机、减速机、工作机连接不当	调整至适当位置，使三者相联轴线同心
		超负荷运转	适当调整负荷
		油封过度磨擦	在油封唇口处滴润滑油
		润滑油杂质多或润滑性差	更换合适新油
		润滑油过少或过多	按油标指示点调整油量
		轴承损坏	更换新轴承
		轴承装配过紧	拆下端盖，调速轴承间隙
环境恶劣，散热差	改变环境，清除散热障碍		
3	漏油	油封唇口磨损	更换油封
		油封档轴颈磨损	更换输出轴或输入轴
		油量过多	按油标指示点调整油量
		放油螺塞未旋紧	螺纹处加密封胶，旋紧螺塞
		油标破损	更换油标
		密封胶失效	拆机更换新密封胶
		螺钉松动	均匀拧紧螺钉
4	杂音	轴承损伤或间隙过大	更换轴承
		润滑油不足	按油标指示点补加润滑油
		机体内有异物	倒净润滑油带出异物，重加清洁润滑油
5	振动	原动机、减速机、工作机固定不良	查出固定不良部位，正确固紧
		轴承磨损	更换轴承
		螺栓松脱	固紧螺栓

8 易损件

- 滚动轴承
- 骨架式橡胶油封

●注意：具体型号、名称由用户自行测量或咨询泰隆技术研发中心。

9 售后服务联系方式

总部售后服务中心 电话 0523-87666499 0523-87669110
传真 0523-87668058

Honorable Tailong Reducer users:

Hello!

Many thanks for buying Tailong brand reducers and enjoying our services.

We will try our best to guarantee trouble free operation, excellent performance and quality of Tailong Reducers.

Tailong After-sales Service Center will provide you with specialized and all-round services.

We hope that the "Instruction Manual" can accompany you in use of Tailong Reducer everytime and everywhere, and enjoy our "specialized and wholehearted" services.

We understand that you -Tailong Reducer users' satisfaction is just our service goal. We will make continuous efforts to turn every use of Tailong Reducer into a pleasant and memorable experience.

Thank you again for choosing Tailong Reducer, and hope more opportunities to provide services for you!

Jiangsu Tailong Reducer Co., Ltd.

Tailong reducer is your best choice



Table of Contents

Overview	1
Packing hoisting receiving storage	2
Installation	6
Operation	8
Lubrication	10
Maintenance and service	17
Common faults and removal methods	20
Wearing parts	21
After-sales Service contact method	21

Gear reduction motor

1 Overview

The manual aims to (including but not limited to): P、K、R、S、CJY、TY。

For use of similar gear reduction motors, can refer to this manual.

Before leaving factory, no-load test has been conducted for reducers; lubricating oil inside reducer has been drained and packed according to regulations of procurement contract. Unless otherwise specified in the contract (if installation assistance required by users), all activities for reducer after leaving the factory are not within our control range. So, the instruction manual reminds and clarifies the following matters:

- . Storage and anticorrosion
- . Transportation
- . Overlong storage
- . Installation
- . Check before startup
- . Reducer running without load
- . Operation and maintenance.

1.1 Implemented standard

Reducers applicable to this manual conform to the following requirements:

Q/321283JBJ08 " TL modular combination gear reducer "

1.2 Applicability

The reducer type is applicable to industry sectors such as metallurgy, mining area, chemical industry, construction material, hoisting, transportation, textile, papermaking, instrument,

plastics, rubber, engineering machinery and energy, etc.

1.3 Working conditions

- a. Maximal speed of input shaft shall not exceed 1500r / min;
- b. Gear peripheral speed not exceed 20m /s;
- c. Working environment temperature is $-10^{\circ}\text{C} - +40^{\circ}\text{C}$, when environment temperature is below 0°C , lubricating oil shall be heated to above 10°C before startup.
- d. Reducer application under specific working condition, refers to Appendix.

●Important: the carrying capacity and thermal power of reducer are selected according to our latest sample. For details, please contact Tailong Technical R&D Center.

2 Packing, hoisting, receiving, storage

2.1 Packing

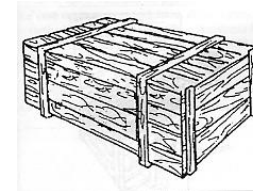

●Important: nude package or part package is generally adopted during transportation. Packing patterns involved in the manual are only for reference, if adopting other packing methods, real packing shall subject to the contract.

a. Uniformly apply antirust grease on shaft extension and key inside packing box, cover closely with plastic film, strap, apply lubricating grease on ancillary gear, shaft and bearing, then fix inside the box.

b. Reducers must be packed with plastic bag, vacuum package

TAILONG

adopted if necessary. Reducer shall be balance placed, without inclination. Shall place waterproof petroleum asphalt felt inside packing box, guarantee dry and clean inside the box.

c. Packing methods mainly include case packing (wooden crate, corrugated case, veneer case, metal case, etc.), nude packing and part package.

2.2 Hoisting

a. When lifting, must correctly lift according to lifting position as shown in packing case drawing, adopt protective measure to prevent wire rope, etc. from scratching its surface. During transportation and storage, reducer shall be placed on wood block or smooth, dry foundation, never directly placed on cement floor. Shall ensure reliable fixing, prevent hitting and axial rotation during transportation. Reducer can be lifted with lug on cabinet (lug, if available on lower cabinet, must be used for hoisting).

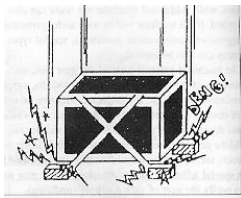

Note: do not contact acid or alkali substance during hoisting.

b. During handling forklift, ensure weight balance on forked plate, prevent side dumping.



If necessary, place wooden wedge under package, easy lifting.

TAILONG

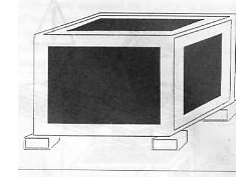

c. When lifting packing box with hook, load on cord shall be stable. And ensure that lifting rope and tool are qualified.

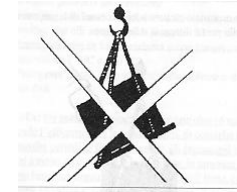
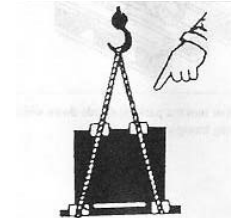

2.3 Receiving



a. The accompanied documents generally include Instruction Manual, conformity certificate, packing list (general packing list and sub-packing list), etc. During packing into multiple boxes, Instruction Manual, conformity certificate, general packing list shall be placed in mainframe box; classified packing list shall be placed in corresponding packing boxes.

b. When unpacking, check whether product model and specification are correct; spare parts and accessories are complete; Whether technical documents are complete; check whether damage,

rustiness occurs during transportation and storage. (if finding damage and rustiness, shall detect the reason and repair, repair quality shall be co-approved by factory and end user before use.) Unless indicated in the contract, 901 phthalein blue green hammer paint shall be sprayed on reducer surface, this protection conforms to requirements of normal industrial environment (also external), in case of application under erosivity conditions, special paint must be used.

● **Important:** in case of any goods abnormality, please contact our Shipment Department, Service Tel: 0523 - 87666499.

2.4 Storage

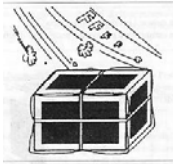

Reducer shall not be stored outdoor. Anti-corrosion period shall be six months storage indoor since the date of shipment. The reducer, if will be stored above six months or work under wet and corrosion environment, shall be indicated in procurement contract, so as to perform specific anti-corrosion treatment after factory test.

If the storage exceeds allowable anti-corrosion period, anti-corrosion treatment shall be conducted again, for concrete method, please contact us.

Shaft seal shall be protected during repainting on external surface of reducer, so as to avoid oil leak on shaft seal due to rubber aging after solvent in paint contacts rubber.

- . Stockpiling together shall be forbidden.
- . Standing or placing article on packing box shall be forbidden.
- . Any other articles shall be not stored in packing box.

. Keep packages far from any travel channel.

● **Important:** the effective life of domestic oil seal is 6 months under normal environment and working condition. Imported oil seal, if used, must be indicated in the contract.

3 Installation

Reducer must be installed by trained and qualified technician, and preparation shall be made strictly according to all technical requirements listed in assembly drawing.

Warning: installation and operation must observe the following requirements:

- . Safety of operator and the Third Party.
- . Operation safety.

3.1 Reducers adopt whole supply, whole installation, so, disassembly and assembly are unnecessary on site. Free change of original gearing structure and any accessory is strictly forbidden. The conditions required for working environment and installation site of reducer

. During high temperature, if cooling conditions for normal working of reducer fail to be met (exceeding allowable thermal power), certain heat exchange measures shall be adopted;

. During low temperature, avoid startup below allowable temperature, and warm up lubricating oil;

. Prevent water and dirt from entering the cabinet.

3.2 **Safety lifting** Lifting and handling shall not hit shaft end, damage internal bearing or cause axial play. Use specialized hanger or eyebolt to ensure lifting appliance with adequate force. Welding hanger shall be absolutely forbidden.

3.3 **Safety opening** Installation or maintenance must be conducted when reducer stops, so, it is an important safety principle to prevent

accidental start of driving source.

3.4 Safety connection When connecting revolving parts such as contacts or belt pulley with driving belt, must supply proper accidental prevention.

3.5 Foundation Reducer foundation can be concrete foundation, steel base or cast iron base. Foundation or base must be secure, reliable and with adequate rigidity. Unreliable foundation will increase operation vibration and noise, influence service life of gear and bearing. Base surface shall have certain flatness and roughness. Base design shall ensure convenient oil drainage, disassembly and assembly of oil return pipe and maintenance, and adequate head drop for oil return by gravity. Gearing with flange shall observe the following requirements:

- Connection of fixed equipment must be rigid, support unpainted plane, very flat after mechanical processing.

- . Proper lubricating oil must be applied on contact surface; reducer must be carefully aligned with driven shaft, especially for gearing with internal spline driven shaft, external load shall not be applied.

3.6 Shaft connection During connection of input shaft, output shaft, power and auxiliary machinery, if using coupler, shafts shall be strictly centered, free of misalignment, otherwise, may generate additional bending moment, even shaft broken, cone belt and chain shall be not overtighten or loosen. In case of larger error, add spacer to prime mover or reducer and enable it within allowable range. Never exceed 3 cushion blocks in height. Configuration of cushion block shall avoid cabinet deformation, and symmetric arrangement on both sides of anchor bolt. Tighten anchor bolt, check on cabinet near bolt with indicating gauge, when bolt loosen, the cabinet moves, which

indicates uneven foundation or cushion block improper, shall center again. For shock load, shall ensure locking of anchor bolt, prevent moving of centering position after working and set puller bolt on base. During working (thermal state) and shutdown (cold state), if larger change occurs at axle center of reducer and machinery connected, shall consider certain compensation to meet the requirements of two states, especially eliminate centering error in thermal state.

3.7 Coupler and lock disc When fitting connectors such as couplers on shaft extension of reducer, never knock with hammer, Making use of the deceleration machine outs the stalk carries the thread, Match the coupler or connects piece press in to go in. For reducer P、K、S appoint with lock disc, lock disc shall be installed as follows:

- a. Remove outer intermediate protective partition in transportation.

- b. Take any three locking screws to form an isosceles triangle, slightly tighten them until inner ring still turns, overtightening will cause deformation of inner ring.

- c. Slide lock disc on shaft sleeve, grease lubrication can be applied on outer ring of shaft sleeve. (Note: never tighten locking screw before loading shaft into sleeve).

- d. Clean grease on shaft and in inner bore of shaft sleeve.

- e. Insert the shaft into shaft sleeve and slide the sleeve on shaft.

- f. Lock disc shall be tighten with torque spanner according to the following specified torque.

Lock disc bolt tighten specification	M12	M16	M20	M24	M27
Tighten torque Nm	75	170	340	590	870

4 Operation

4.1 Check before startup

Before startup, shall conduct the following checks in sequence, confirm errorless before trial run:

- ① Correctness of installation site
- ② Reliability of every fastener;
- ③ Whether the height of splash lubrication oil level conforms to requirements, oil grade and viscosity conform to working requirements:
- ④ For circulating oil lubrication system, cooling system and monitoring system, shall check:
 - . Pipeline connection accuracy;
 - . Reliability of every fastener on pipeline;
 - . Pipeline direction accuracy;
 - . Whether pressure gauge, monitor, control device, switch are secure and reliable;
- ⑤ Whether turning direction of prime mover is correct;
- ⑥ Whether coupler protection hood, earth wire and other protection unit are installed.

4.2 Trial run

No-load test run shall be conducted for about 2 hours according to working speed after reducer installed.

. For oil-bath lubrication reducer, when environment temperature is lower than allowable minimum temperature of lubricating oil, lubricating oil shall be warmed up before startup, in order to reduce starting torque (otherwise, may damage gear or burn motor) and enable oil splash to every lubricating oil point.

. During oil-bath lubrication, oil level shall be monitored with ullage table or oil gage, which has been calibrated in factory. Oil level shall vary with working speed of different users. Overhigh oil

level may cause severe stirring of lubricating oil inside reducer, increase power consumption, cause excessive temperature rise; too low oil level may cause poor lubricating and early failure of bearing and gearing. During trial run, please open sight board on tank cover, observe oil splash status, oil can splash to oil collector inside cabinet and adequate lubricating oil can splash to oil sump above bearing shall be treated as optimal oil level. In case of larger difference between oil level and original scale, please recalibrate the scale.

. For reducer with circulating oil lubrication system, ullage table or oil gage are only for reference. Lubricating oil shall be heated to above 0°C before startup. Firstly start lubricating oil system, check whether oil supply to gear, bearing is normal, supply pressure is within specified range, oil return is normal, firstly circulate lubricating oil for about 30 minutes.

Normal oil supply pressure: 0.12- 0.25Mpa

4.3 Load operation

Link working machine, dry run for 2 hours, then increase load as per 25%, 50%, 75%, until operation at full load.

Tooth face contact and fastener loosen shall be checked a period after load operation. After everything is normal, can enter normal application.

5 Lubrication

●**Note:** Tailong Reducer is supplied without lubricating oil, so, please correctly add lubricating oil before startup.

5.1 The reducer shall adopt common 3# industry grease.

5.2 The reducer generally adopts middle load industrial gear oil L - CKC220, L - CKC320 in GB5903. Lubricating oil (mineral oil)

TAILONG

viscosity and brand recommended for reducers under different environment temperatures as follows:

Slow-speed shaft speed r/min	Lubricating oil standard	Environment temperature°C		
		-10~+15	0~+30	+10~+50
≤100	ISO GB AGMA	VG150 150 4EP	VG320 320 6EP	VG460 460 7EP
>100	ISO GB AGMA	VG100 100 3EP	VG220 220 5EP	VG320 320 6EP

a. **Oil level** Gear reducer generally adopts oil bath lubrication, before use, must add oil to specified position (the diagram shows the position) and periodically complement.

TAILONG

P series gear reducer motor oil level, screw plug, vent cap location map

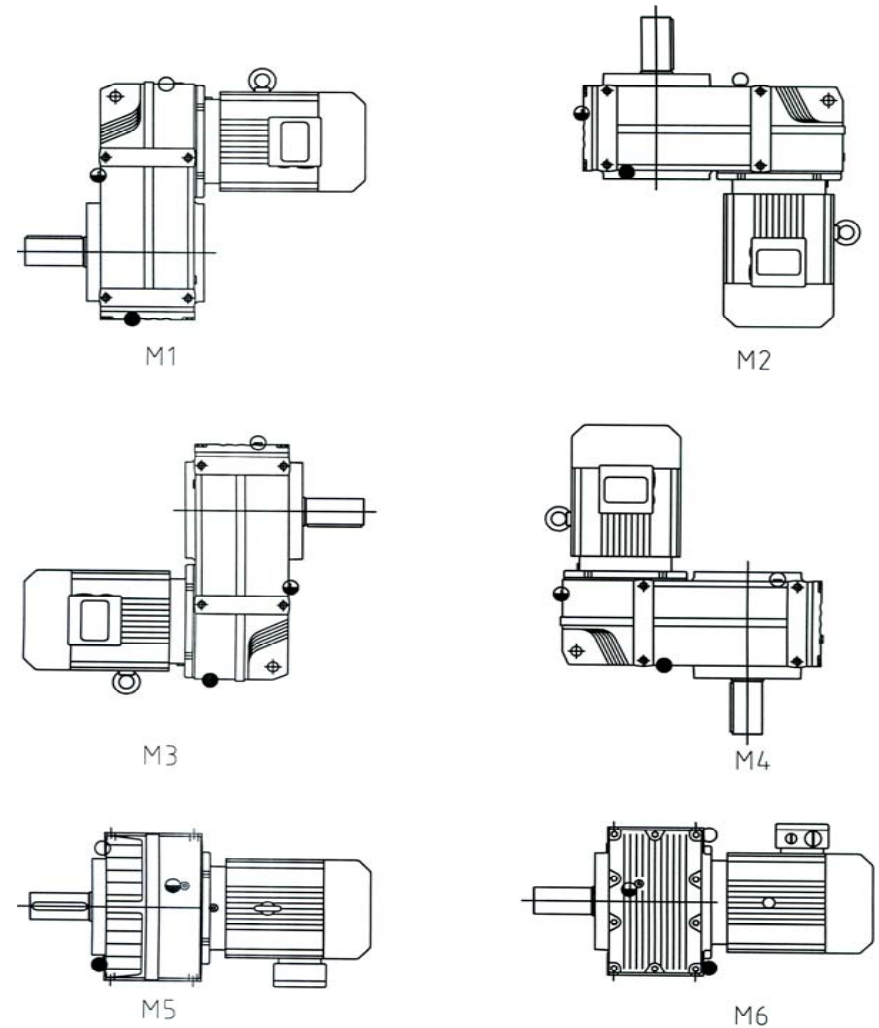

○ filling aperture ● oil level hole ● oil drain hole

R series gear reducer motor oil level, screw plug, vent cap location map

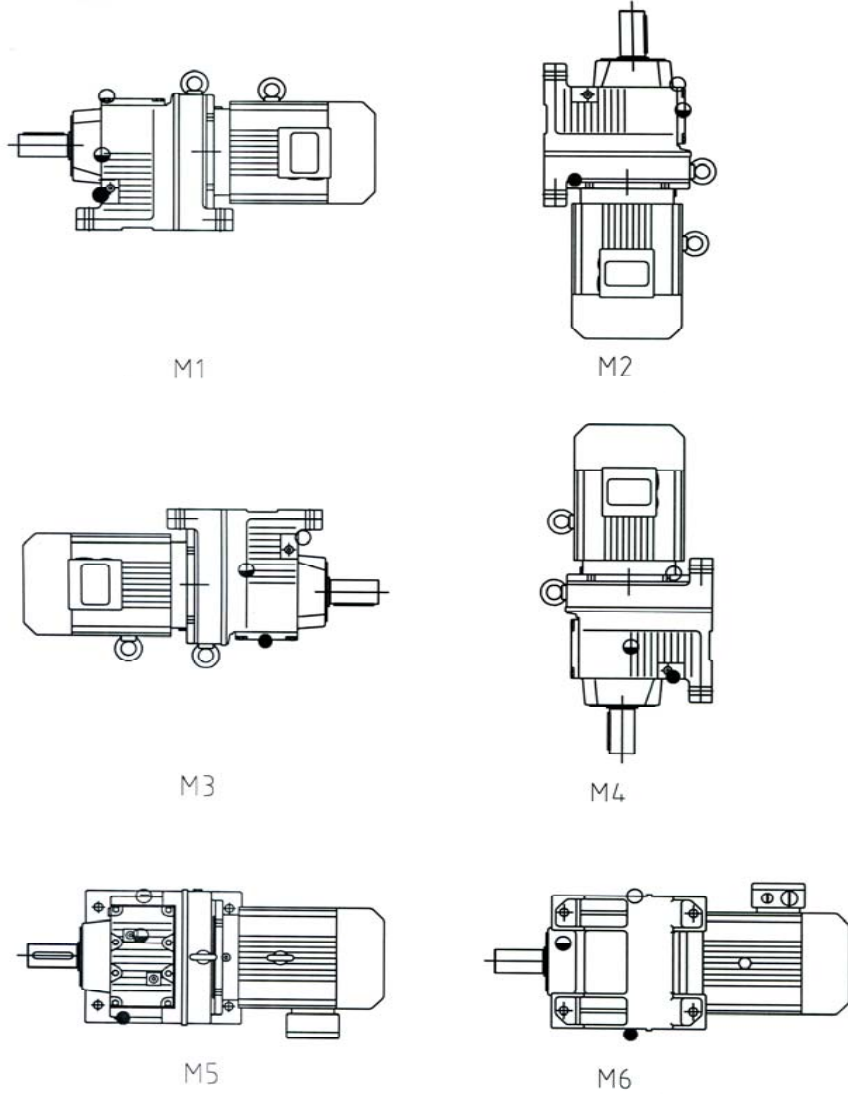

○ filling aperture ● oil level hole ● oil drain hole

K series gear reducer motor oil level, screw plug, vent cap location map

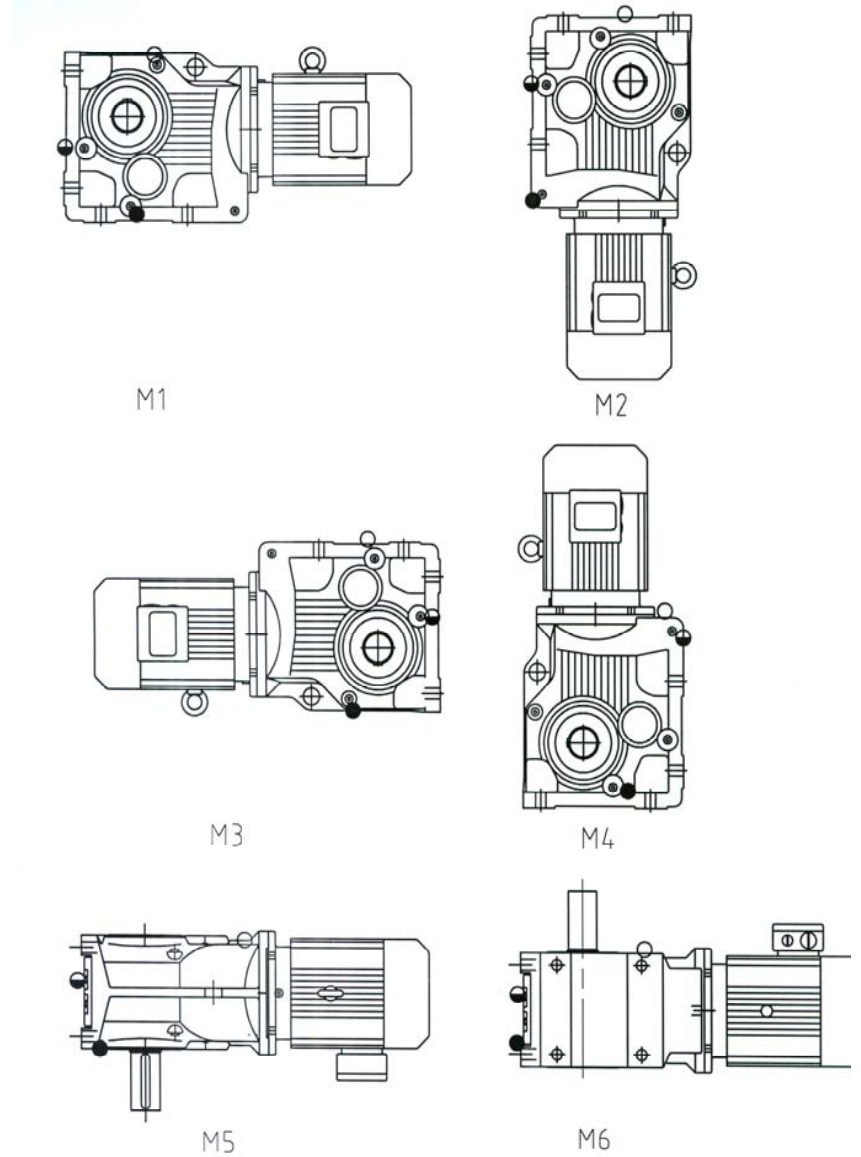

○ filling aperture ● oil level hole ● oil drain hole

S series gear reducer motor oil level, screw plug, vent cap location map

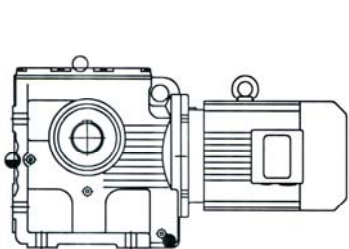

M1

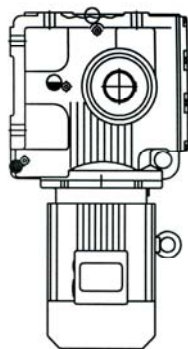

M2

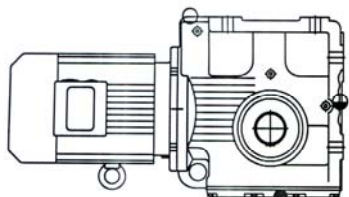

M3

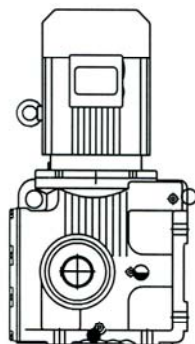

M4

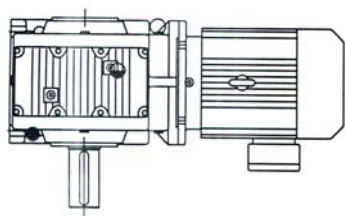

M5

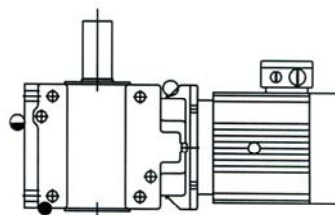

M6

○ filling aperture ● oil level hole ● oil drain hole

b. **Oil change period** Oil must be replaced after running-in period of 7- 14 operation days (150- 300 hours) since the first use of new reducer. New oil must be replaced for the second time when operation reaches 3 months. During application, shall conduct periodical inspection on oiliness, replace oil with impurity, pollution or resolved, aged and deteriorated oil. Generally, replace oil every 6-8 months for long-time continuous operating reducers; every 10-12 months for reducers working not more than 8 hours everyday.

c. **Oil product** new oil brand must be equal to original oil brand, do not mix different brands and types.

Before injecting new oil, heat the oil whose type is similar to operating oil, then clean gear with it.

d. **Oil temperature** Working temperature allowable to reducers depends mainly on lubricating oil types, overhigh oil temperature will accelerate the ageing of lubrication, and shorten oil draining period (uneconomic).

5.3 **Lubrication** Reducer generally adopts oil bath lubrication, natural cooling.

When equilibrium temperature of working reducer exceeds 90°C or load-bearing power exceeds thermal power PG1, can lubricate with circulating oil, or adopt cooling pipe oil way lubrication.

When restarting after continuous reducer shutdown exceeding 24h, shall ensure sufficient lubrication of gear and bearing before load running.

5.4 **Bearing lubrication** Lubricating oil and lubricating grease are normally adopted for rolling bearing in reducer.

When selecting lubricating oil, shall consider the factors such as bearing load, rotation speed, temperature and working environment,

etc. For larger bearing load and higher temperature, the lubricating oil with higher viscosity shall be adopted. For smaller bearing load, lower temperature and higher rotation speed, lubricating oil with smaller viscosity can be adopted.

Excessive or insufficient lubricating oil in bearing may cause bearing overheat. When bearing speed $n = 1500r / \text{min}$, oil level shall not exceed the center of rolling body on lower part of bearing. When $n > 1500r / \text{min}$, oil level shall be lower.

Grease lubrication can be adopted when peripheral speed of bearing turning seat ring does not exceed $4 - 5m / \text{h}$. When adopting grease lubrication, the filling of lubricating grease into bearing can occupy $1/3$ to $1/2$ of bearing chamber.

Lubricating method of rolling bearing in reducer, can directly utilize lubricating oil in reducer oil sump, in this case, must introduce lubricating oil inside reducer oil sump into bearing.

●Note: Tailong Technical R&D Center has selected proper lubrication method according to application status during designing reducer.

6 Maintenance and service

6.1 **Spare parts manufacture** Ensure periodical reducer inspection and repair. When finding scratch, gluing and evident abrasion, must adopt effective measures. Spare parts must be manufactured according to standard, renewed spare parts can be put into formal use only after running-in and trial run with load.

6.2 **Driving check** During application, shall monitor flexibility of every driving part, analyze abnormal sound and high-temperature symptom found, timely handle hidden trouble, when finding abnormal sound in bearing, shall timely check, if necessary, shall immediately

replace bearing, otherwise, may cause serious gear damage. If fails, shall immediately conduct shutdown inspection, and contact our After-sales Service Department.

6.3 **Oil mass oil pressure** Frequently check bolt fastening and oil mass. Oil shall be timely added when reducer oil level is below the lower graduation line of oil scale. The change of oil pressure shall be noted during circulating oil lubrication, in case of apparent reduction in oil pressure, oil cleaner screen shall be checked and cleaned.

6.4 **Heat elimination check** To facilitate heat elimination of reducer, external surface shall be clean, venthole free of choking. If cabinet temperature rise is overhigh, shall check whether oil level is overhigh, heat dissipation conditions surrounding are poor, oil aged, cooling water insufficient, scaling inside cooling coil or poor cooling effect, etc.

6.5 **Oil leak check** If finding oil leak on high speed shaft, shall check whether oil level is overhigh. In case of oil leak on shaft seal due to aging or abrasion, inject proper consistent grease through grease nipple on end cover, in case of severe oil leak, user shall timely replace oil seal.

●Important: 8 hours after reducer operation, no oil leak only at small area of infiltration oil near oil seal, oil leak on infiltration oil area extended to base, oil accumulated on foundation is oil leak.

6.6 **Safety protection** Protection hood shall be set for exposed rotating part of reducer, motor or other electrical equipment shall be earthed.

●Important: never remove sight window during reducer operation, so as to prevent personal injury due to splash of high temperature

gear oil.

6.7 **Change oil** During normal operation, due to surface continuous running, metal chips inevitably enter mobile oil. These dirt will shorten bearing life, cause gearing damage ahead of time, so, it is necessary to frequently replace mobile oil.

6.8 **System management** Users shall establish rules and regulations on reasonable use and maintenance, record the problem found in operation and inspection of reducer.

● **Important:** if unfamiliar with installation and use of reducer, but must disassemble mainframe equipment or reducer due to requirement of maintenance, please contact us for our technical support or approval. If reducer or other equipment fails or damaged due to user's private installation or disassembly, the responsibility shall be undertaken by the user.

7 Common faults and removal methods

Serial no.	Symptoms	Reason	Removal method
1	Oil tube without oil	Oil level too low	Add lubricating oil
		Oil way choking	Remove oil pump and clean
		Oil pump damage	Replace oil pump
2	Overheat	Prime mover, reducer, working machine connected improperly	Adjust to proper position, enable concentric axial line
		Overloading operations	Proper
		Oil seal excess friction	Apply lubricating oil at oil seal lip
		Lubricating oil with multiple impurity or poor lubricity	Replace oil
		Lubricating oil insufficient or excessive	Adjust oil mass as per oil pointer
		Bearing failure	Replace bearing
3	Oil leak	Bearing assembly overtight	Remove end cover, adjust bearing clearance
		Environment rough, heat elimination poor	Change environment, clear heat elimination obstacle
		Oil seal lip abrasion	Replace oil seal
		Oil seal journal abrasion	Replace output shaft or input shaft
		Excessive oil	Adjust oil mass as per oil pointer
		Oil draining screw plug not tighten	Apply sealant at thread, tighten screw plug
4	Noise	Oil gage failure	Replace oil gage
		Sealant failure	Disassemble and replace sealant
		Bolt loosen	Uniformly tighten bolt
5	Vibration	Bearing damage or gap excessive	Replace bearing
		Lubricating oil insufficient	Add lubricating oil as per oil gage
		Foreign matter inside body	Drain lubricating oil to remove foreign matter, re-apply clean lubricating oil
5	Vibration	Prime mover, reducer, working machine fixed improperly	Check poor fixing points, correctly tighten
		Bearing wear	Replace bearing
		Bolt loosen	Binding bolt

8 Wearing parts

- . Rolling bearing
- . Skeleton rubber oil seal
- . Note: For concrete type, name, please self- measure or contact

Tailong Technical R&D Center.

9 After-sales Service contact method

Headquarters After-sales Service Center

Telephone: 0523-87666499 0523-87669110

Fax: 0523-87668058